

**E**

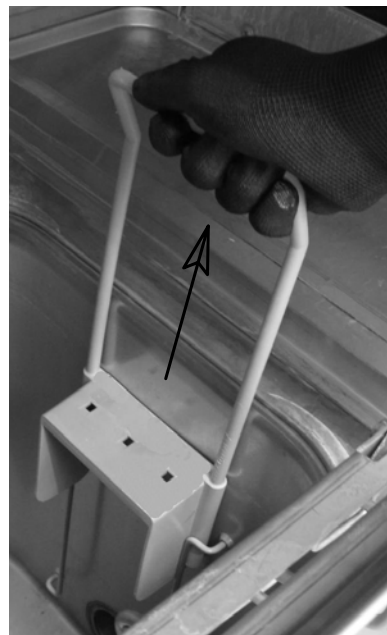

**F**



**G**

**Fig.8**

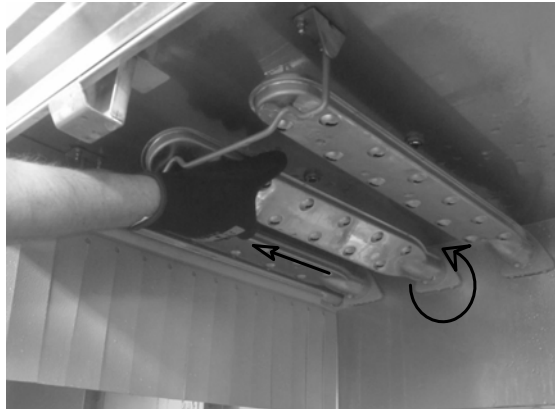
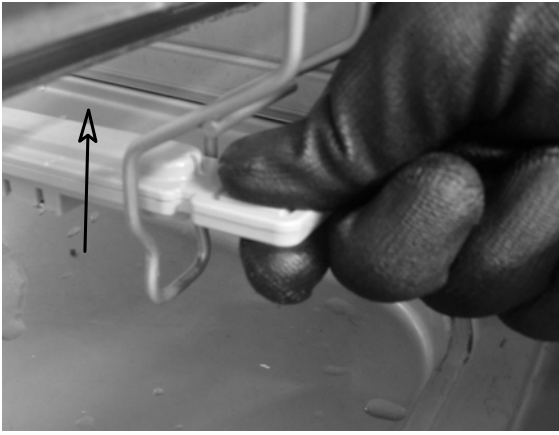

**Fig.9**



**Fig.10**

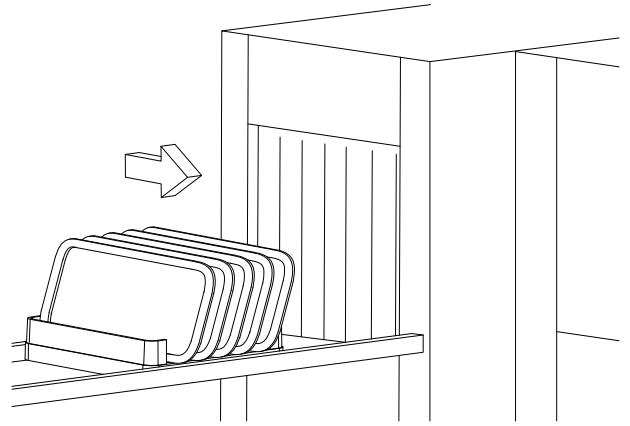

**Fig.11**

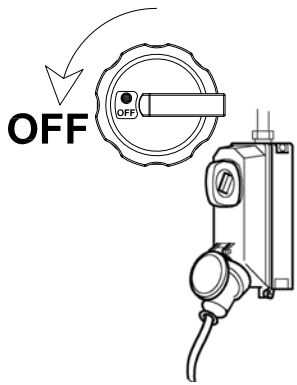

**A**

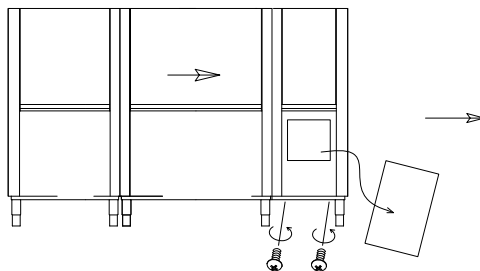

**B**

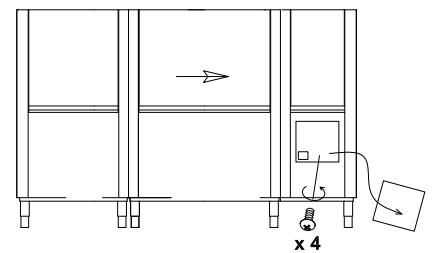

**C**

0600  
0413

○	□	○	□	■	□	○
○	□	○	□	■	□	○
○	□	○	□	■	□	○
○	□	○	□	□	□	○
○	□	○	□	□	□	○
○	□	○	□	□	□	○

0600  
0413

○	□	○	□	■	□	○
○	□	○	□	■	□	○
○	□	○	□	■	□	○
○	□	○	□	□	□	○
○	□	○	□	□	□	○
○	□	○	□	□	□	○

**D**

**Fig.12**

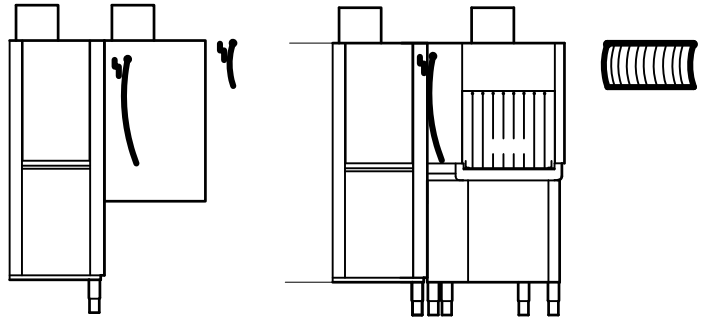
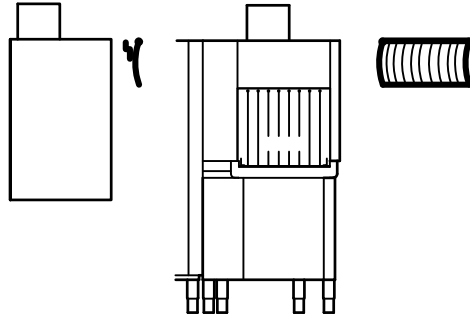
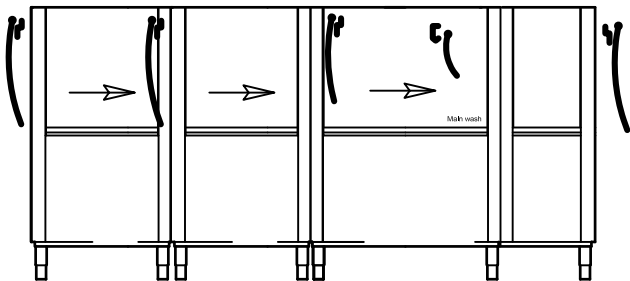
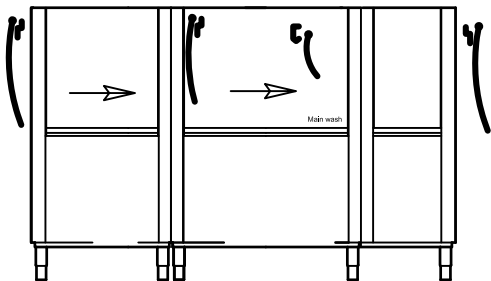
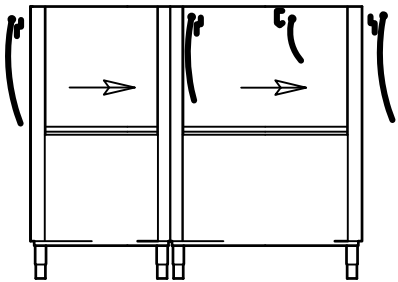
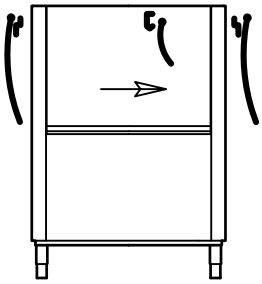

**DRYER**

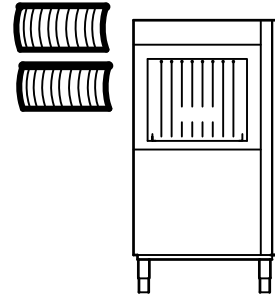

**ANGLE PRE-WASH**

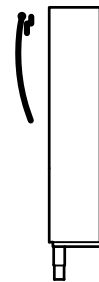

**DIN MODULE**

**Fig.13**